

# JETPAN 900

Jetpan 900 is a special solution, where wide lane with high wings required, along with features of passage detection. This speed gate can detect and alarm unauthorized passage, triggering security personnel to take required action. While for authorized passage, the system can be connected to a time & attendance system, an output signal is generated only when actual passage is done, which is arranged by a means of optical sensors. 900 mm passage width is suitable for people with determination and carrying bulky items.



HIGHER WINGS FOR HIGHER LEVEL OF PROTECTION

IDEAL SOLUTION FOR ANY DEMANDING SITE



## Key features:

- The innovative motor controller with an OLED display and buttons for easy setup and configuration without special programmers.
- The Jetpan smart self-diagnostic system automatically detects critical malfunctions, and records error log and warnings.
- The safety sensors system allows detecting the passage of a person with luggage, or arranging a free exit without necessity of identification.
- In case of power failure, flaps are free to be open manually (fail-safe).
- The ability to customize cabinet and top lid design as per project requirements.
- Jetpan supplied with wired push button by default.
- Availability of integration with any access control system.
- Low power consumption.
- Elegant cabinets are equipped with integrated LED lighting to display access status and card reader area.

# TECHNICAL SPECIFICATIONS /

Model	Jetpan 900
Cabinet width, mm	620
Cabinet length, mm	1005
Cabinet height, mm	1000
Leaves height, mm	1520/1800
Passage width, mm	900
Opening/closing time, sec	2,2
Mechanism	Servodrive
Blocking system	Electromagnetic brake
Emergency mode (fire-alarm)	Free entry/exit (leaves are opened automatically)
Power fail	Fail safe (gates could be opened manually — standard)
MCBF, cycles	5 000 000

## Electrical Specifications:

Maximum power consumption, W	160
Voltage	From the AC (100-240)V, 50/60Hz; from a DC source 12 V
Indication	DotLights®, RFIDLights®, LeafLights®

## Finishing

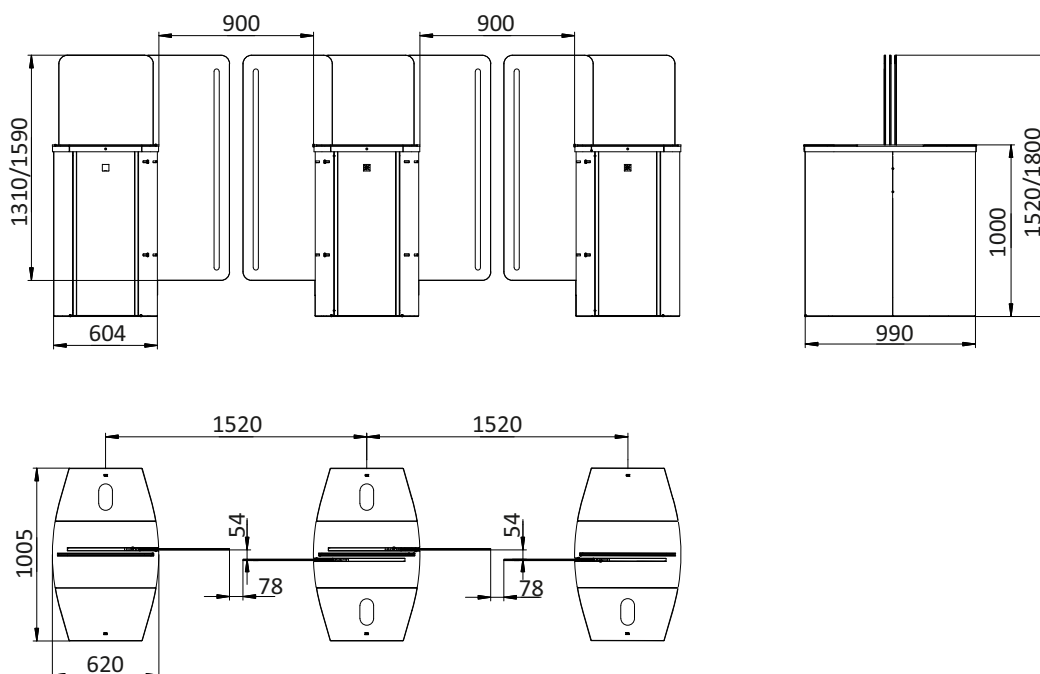

Standard housing	Brushed SS AISI 304
Available housing	Brushed SS AISI 316; Polished SS AISI 304; Polished SS AISI 316; Powder coated RAL



Dimensions for solid glass top lid

Specifications are subject to change without prior notice



 [www.tiso.global](http://www.tiso.global)  
 +380 (44) 291-21-11  
 [sales@tiso.global](mailto:sales@tiso.global)



# STANDARD FEATURES

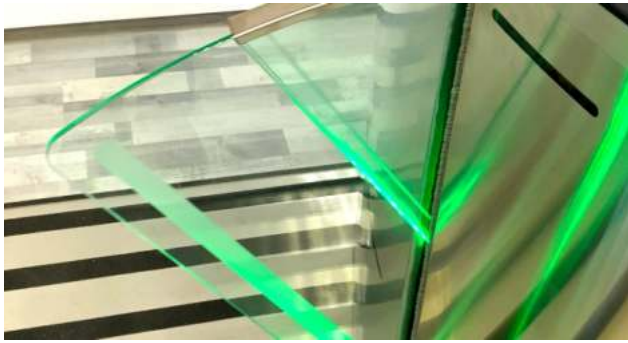

## LEAFLIGHT®

Impressive illumination of the leaves can be in three colors (standard), marking the status of passage: blue - standby mode; green - access authorized; red - access denied.



## CONTROL PANEL

The wired control panel goes in a standard set. Allows to implement a single passage, a free passage, as well as blocks an access and activates the anti-panic function.



## SAFETY SENSORS, ANTI-TAILGATING FUNCTION

High-precision sensors that identify the unauthorized passage of two or more people (antitailgating function). At the same time safety sensors guarantee safe passage for people with luggage or trolleys - the gates won't close until the person finishes the passage.



## UPS FUNCTION

A complex UPS system that automatically switches power to work from the back-up battery. This allows you to use all the functions of the speed gate in case of power fail.



## LED INDICATIONS

Bright and attention-grabbing RFIDLight® (LED light of card reader area) and DotLight® (LED lighting display showing access status).



## PLACE FOR RFID INSTALLATION

Place for RFID installation is provided in the standard configuration of the speedgate.

# ADDITIONAL OPTIONS /

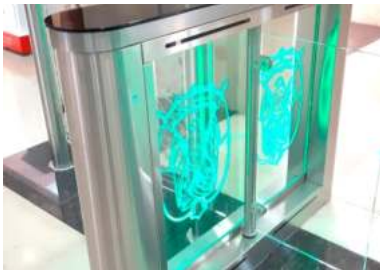

## PATTERN APPLICATION

Unique signatures, customized patterns, logos and others can be placed on the leaves, housing or top lid of speed gates.



## MP3 AUDIO MODULE

Audio signals for unauthorised access / authorised access / closing / opening / alarm.



## KEYFOBS FOR RADIO REMOTE CONTROLLER

Minimalistic keyfobs for opening and blocking the passage.



## INTEGRATION OF CUSTOMIZED ACS

Any access control systems upon request (e.g. RFID device, coin acceptor push button, fingerprint, face recognition, barcode and QRcode reader).



## TWIC WIRELESS CONTROL PANEL

TiSO TWIC were developed for the remote control of multiple lines of turnstiles. The space saving 10" touch screen display can be located at a reception desk or within security control areas.



## SUPER CAPASITOR

Maintenance of a free power package for emergency automatical one time opening of the speed gate.



## FOOTPRINT ILLUMINATION

LED illumination of the footprint of the speed gate housing. The color of the light may vary depending on your request.

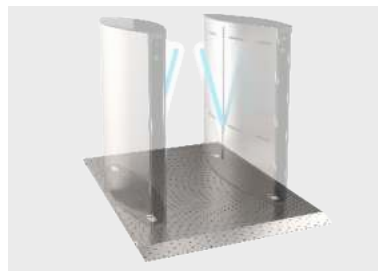

## MOBILE PLATFORM

Ensures quick temporary speed gate installation. As well as can be installed in areas where it is impossible to drill the floor.



## EXIT BUTTON

A convenient option that allows you to organize an exit by using a touch free button.

# ADDITIONAL OPTIONS /

RANDOMIZER  
RANDOMIZER  
RANDOMIZER

## RANDOMIZER

This mechanism automatically randomly selects a person for verification, without the influence of the human factor.



## CARD COLLECTOR INTEGRATION

Possible to integrate the automatic card collector into the speed gate housing.



## RFID READERS T-PROX MINI

Reader operates with 125 kHz cards, Mifare, Mifare Plus and mobile credentials U-Prox ID over NFC and over 2.4 GHz radio.



## JUMPING OVER TOP LEAD ALARM

Weight sensors detect over 10 kg impact on the top lid and activate alarm.



## COUNTER OF PASSAGES

Automatic counting of the number of passes.

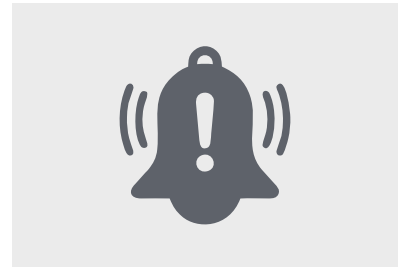

## ALARM BUZZER

Sound alarm during unauthorised access.